













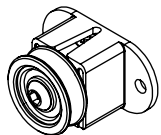
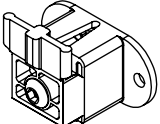

7200.760/761/764/355/354

					A - 22x	B - 22x	C - 22x
							
					Ø 15x13mm 0512.042	Ø 7x41mm 0512.041	Ø 8x40mm 0540.004
D - 2x	E - 24x	F - 4x	G - 2x	H - 2x	I - 8x	J - 4x	K - 10x/8x
							
Ø 60x24mm 0520.163/ 0520.164	Ø 4x16mm 0512.001	Ø 6,5x16mm 0900.174	41x27x23mm 0516.085	41x29x27mm 0516.085	Ø 3x12mm 0516.085	Ø 10x3mm 0520.063	Ø 20x0,5mm 0520.011/ 0520.171/ 0520.165

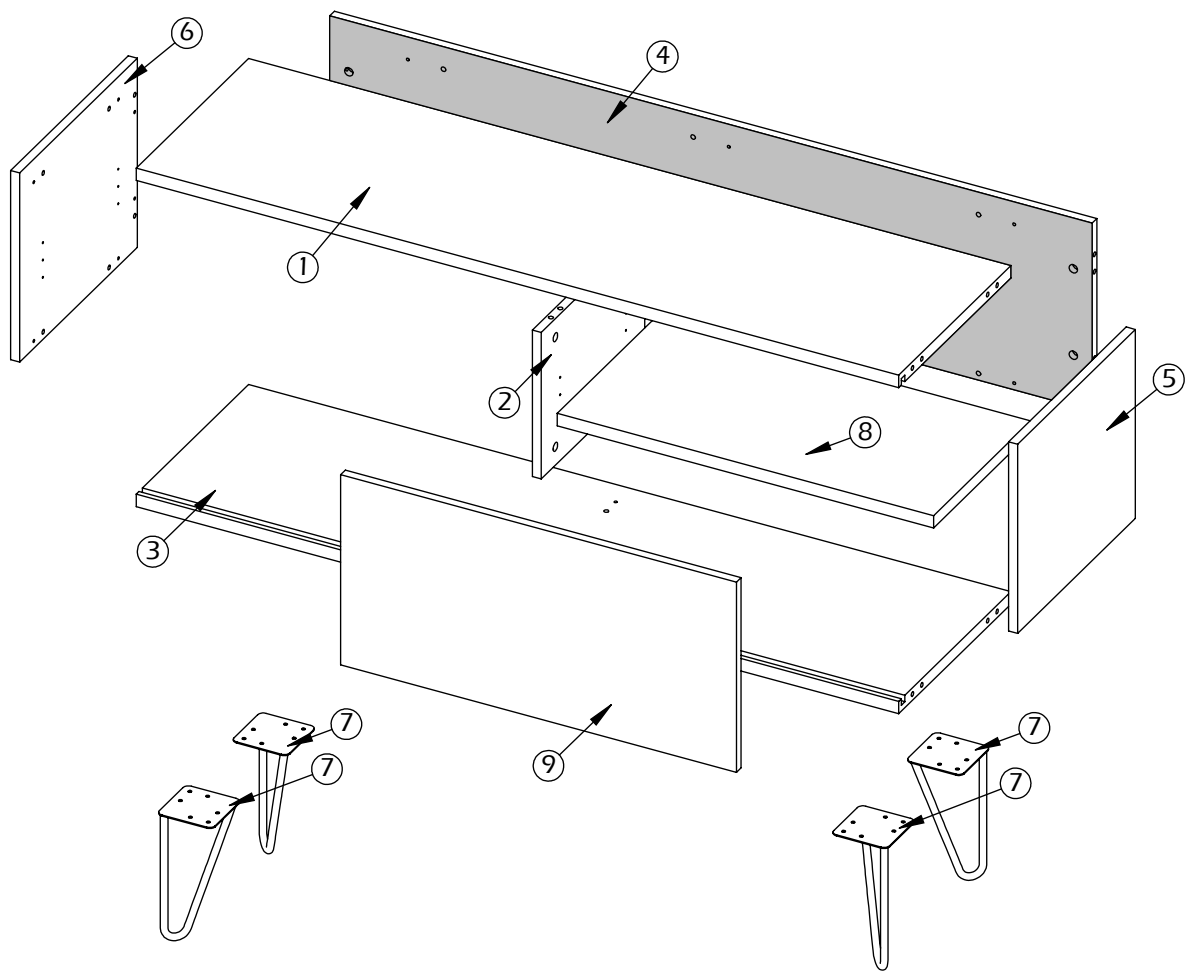
IM-0623.1087/3



1	A-11x 	B-2x 	C-11x 
	Ø15x13mm	Ø7x41mm	Ø8x40mm

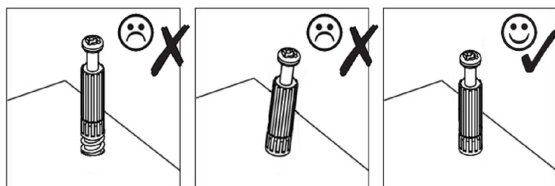
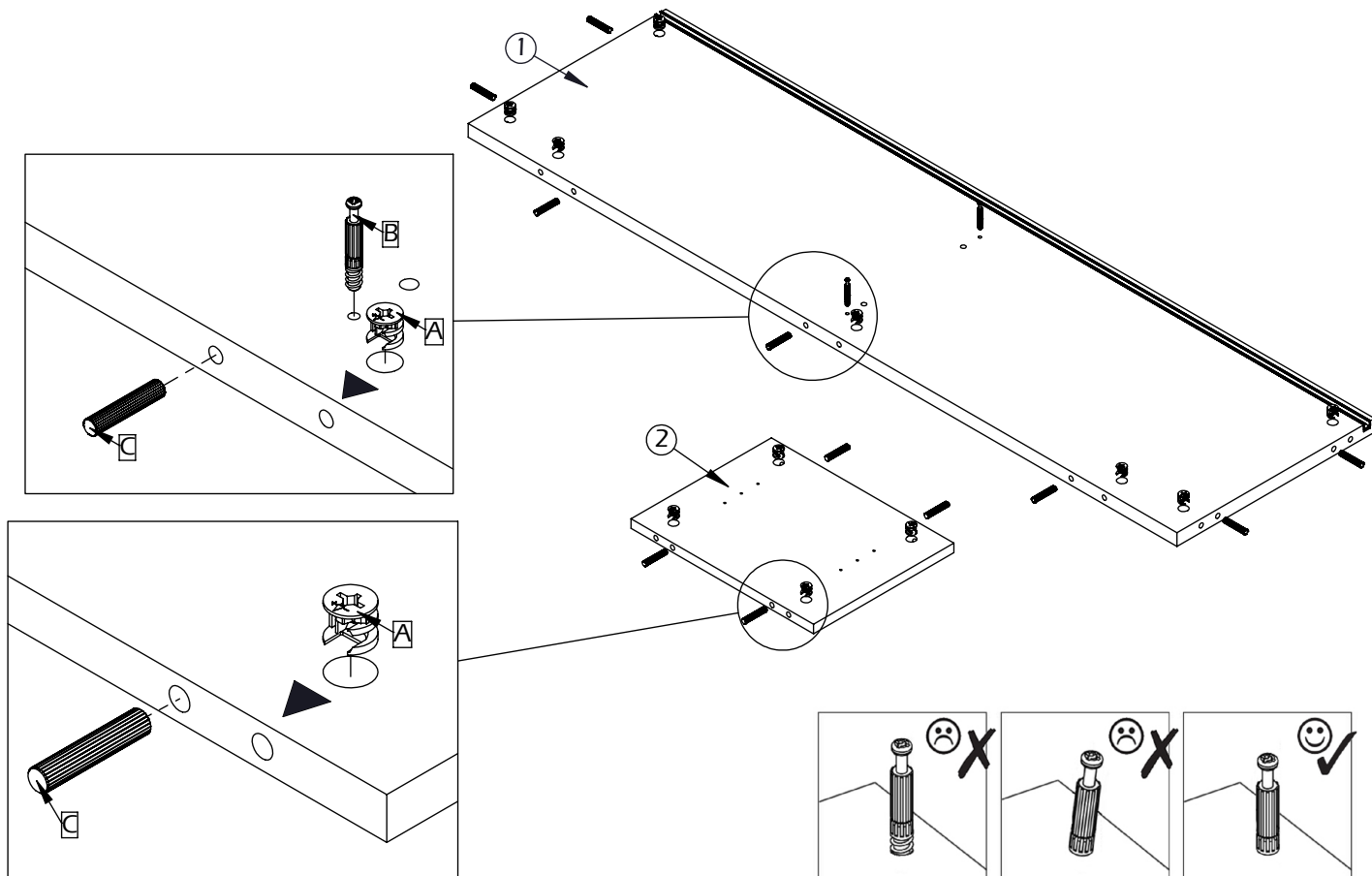
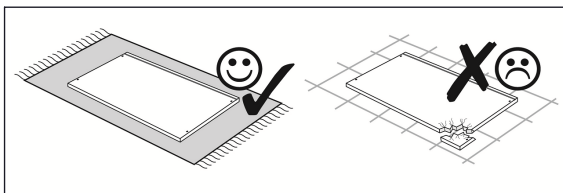

2

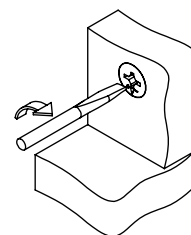
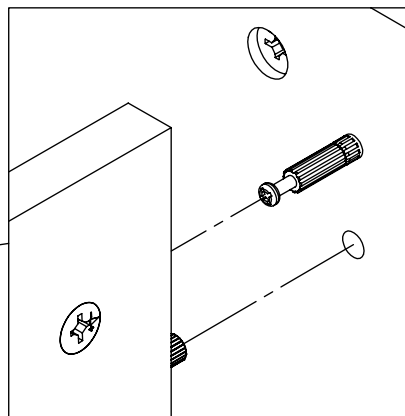
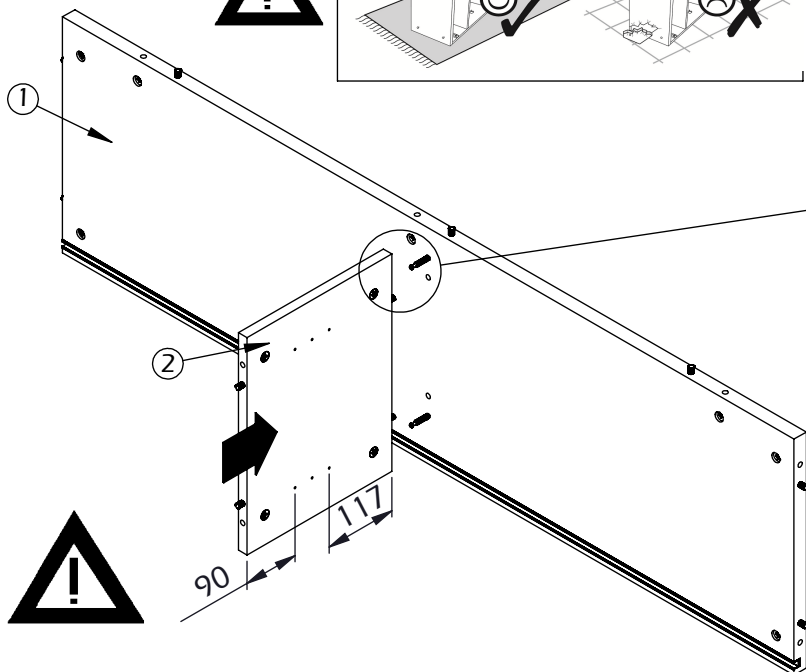
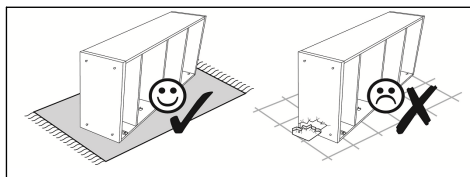

3

A-7x



Ø15x13mm

B-2x



Ø7x41mm

C-7x



Ø8x40mm

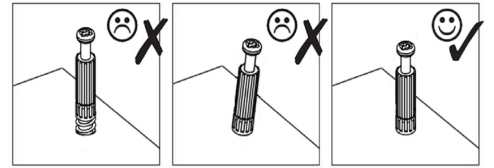
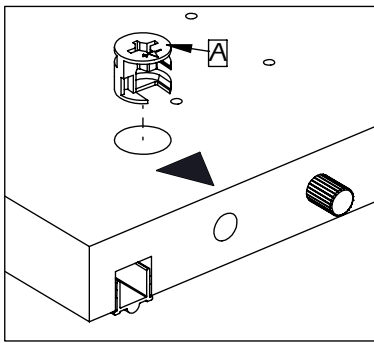
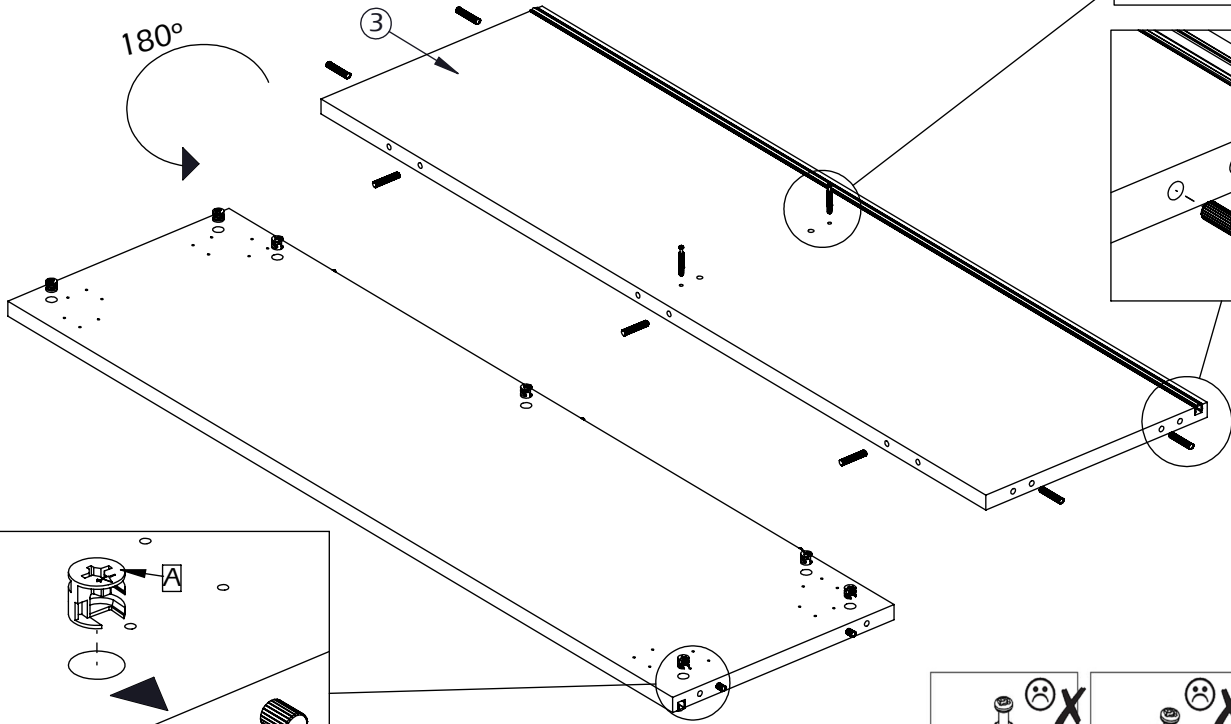
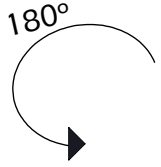
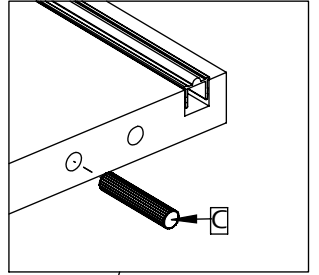
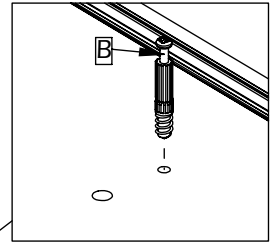
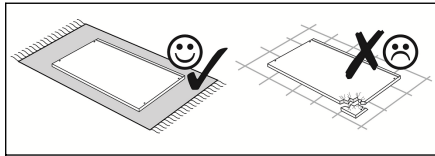

4

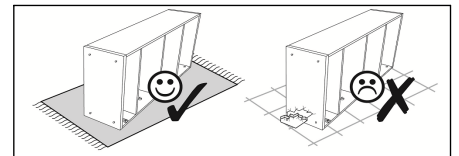

3

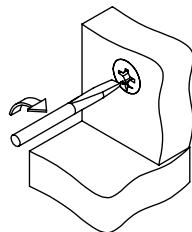
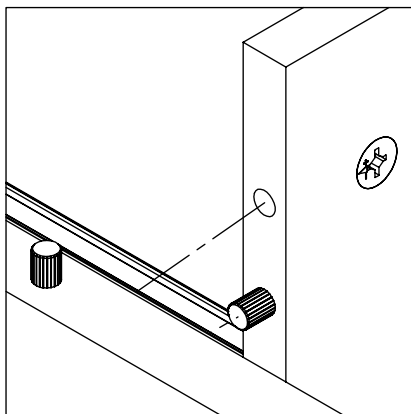

5

A-4x



B-6x



C-4x



D-2x



Ø15x13mm

Ø7x41mm

Ø8x40mm

Ø60x24mm

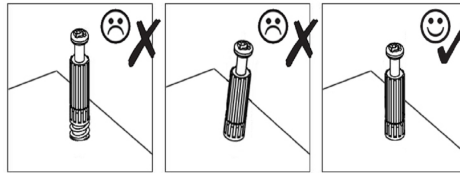
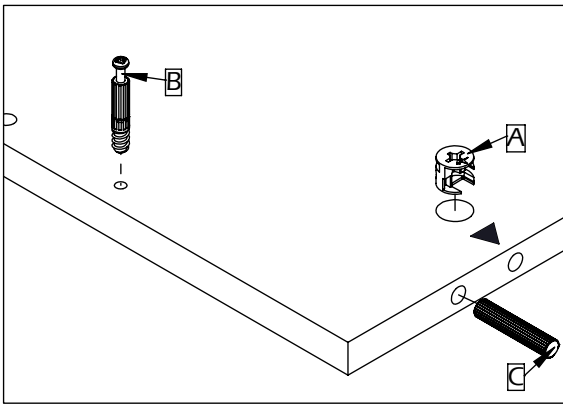
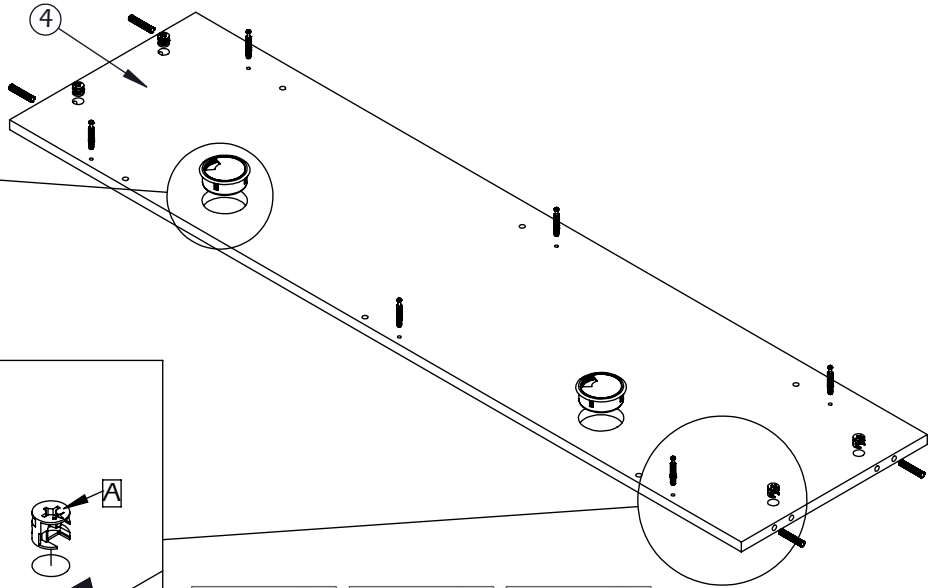
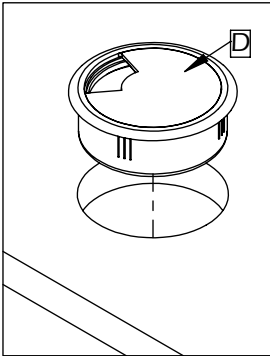
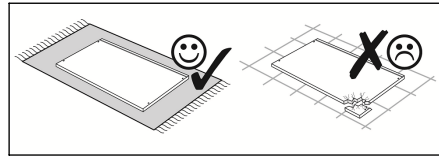

6

180°

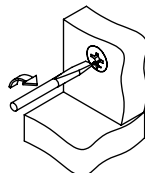
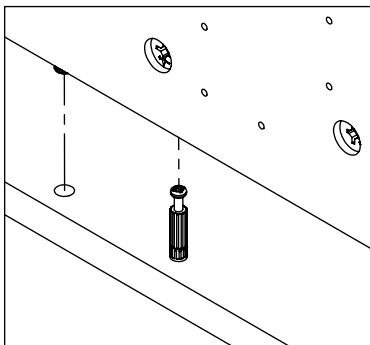
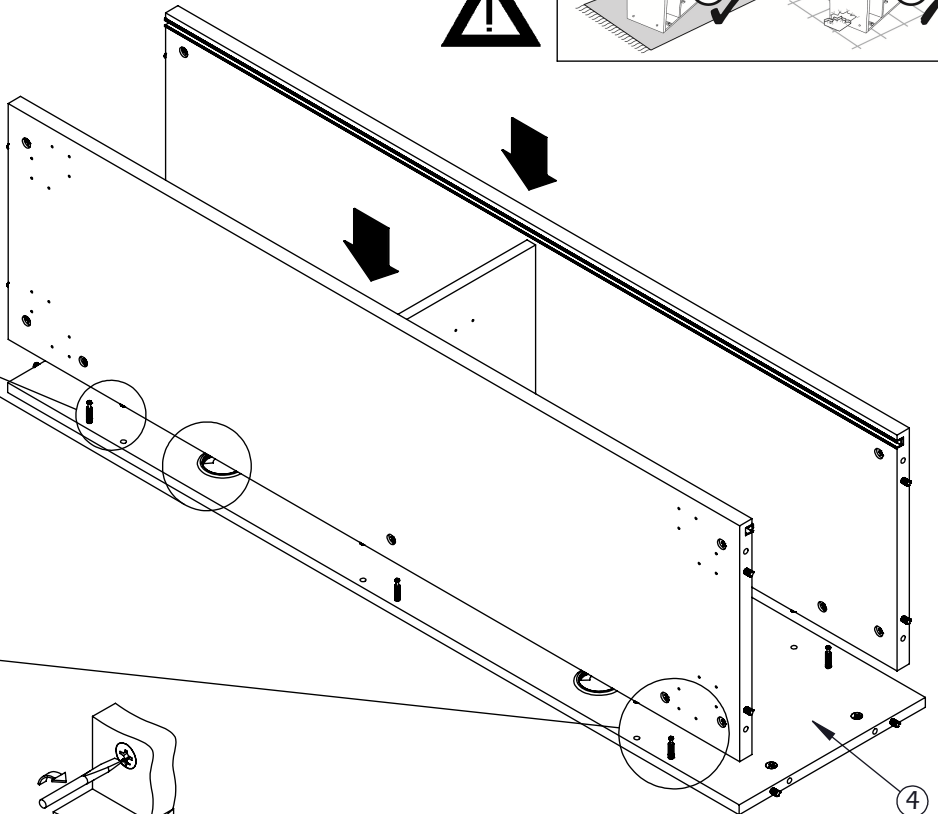
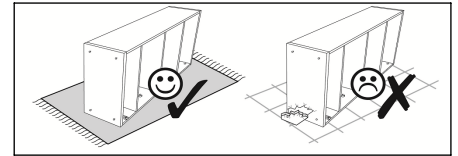
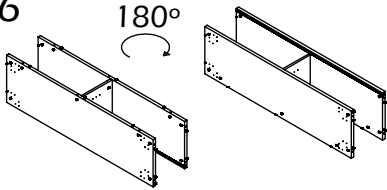

7

B-12x



Ø7x41mm

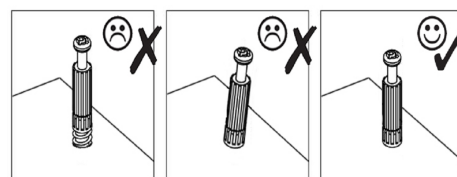
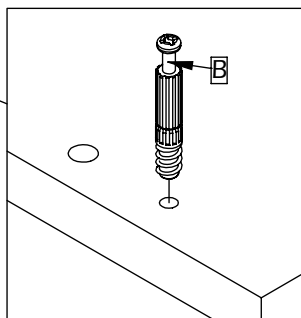
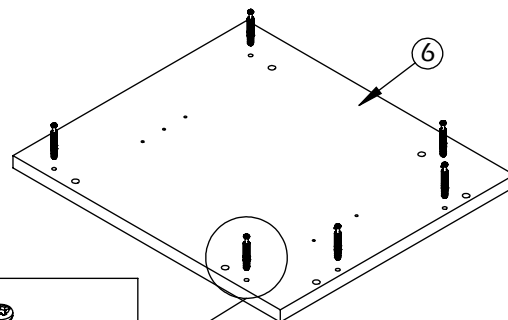
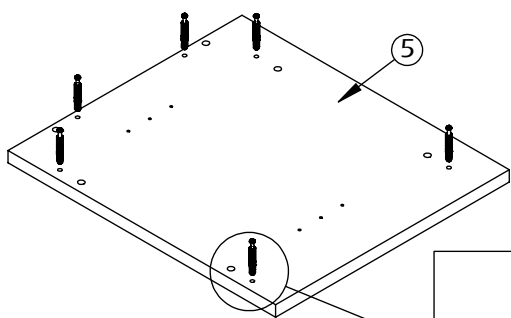
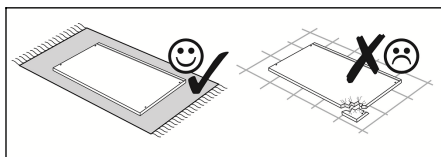

8

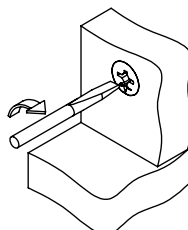
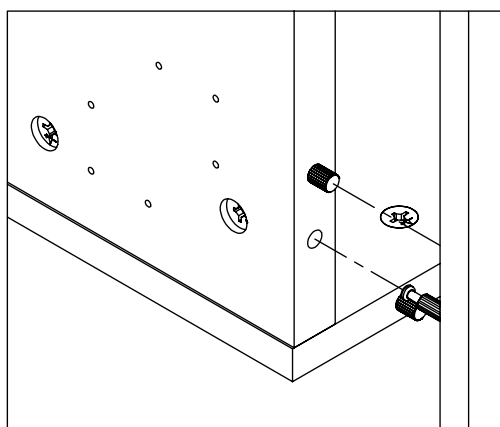
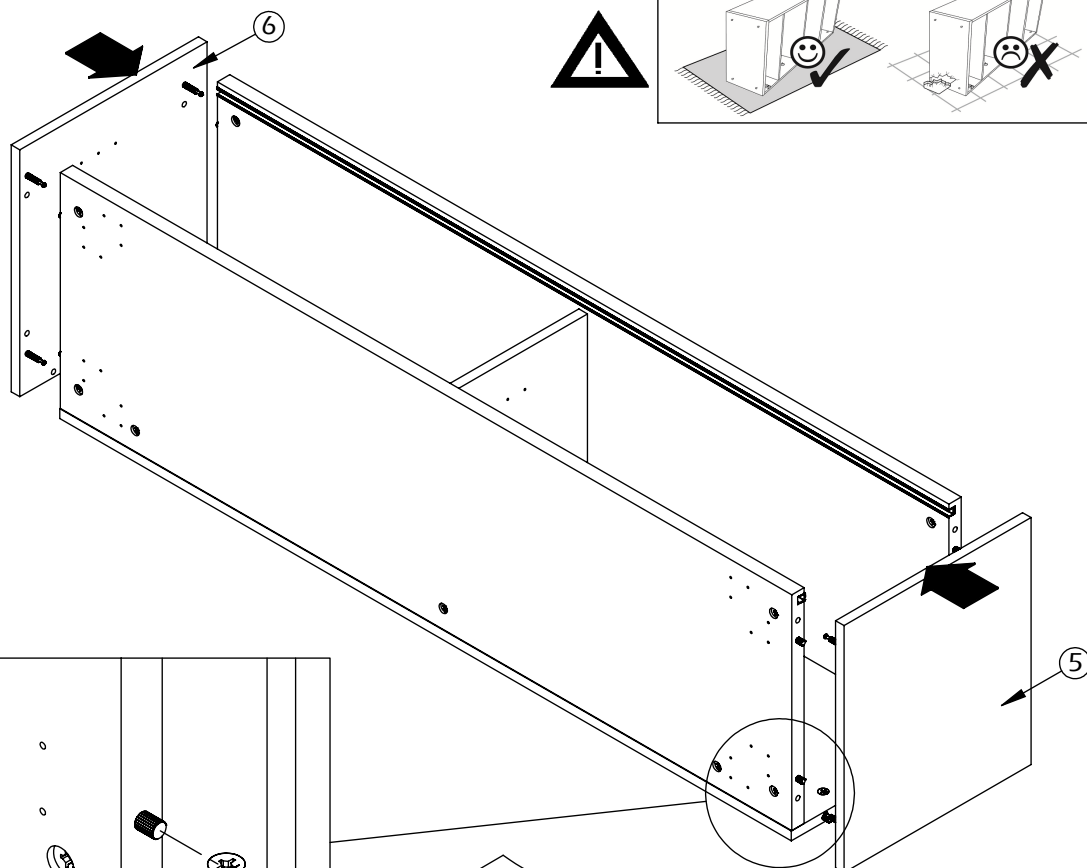
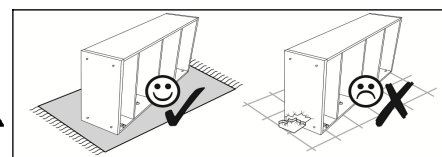

9

E-24x



Ø4x16mm

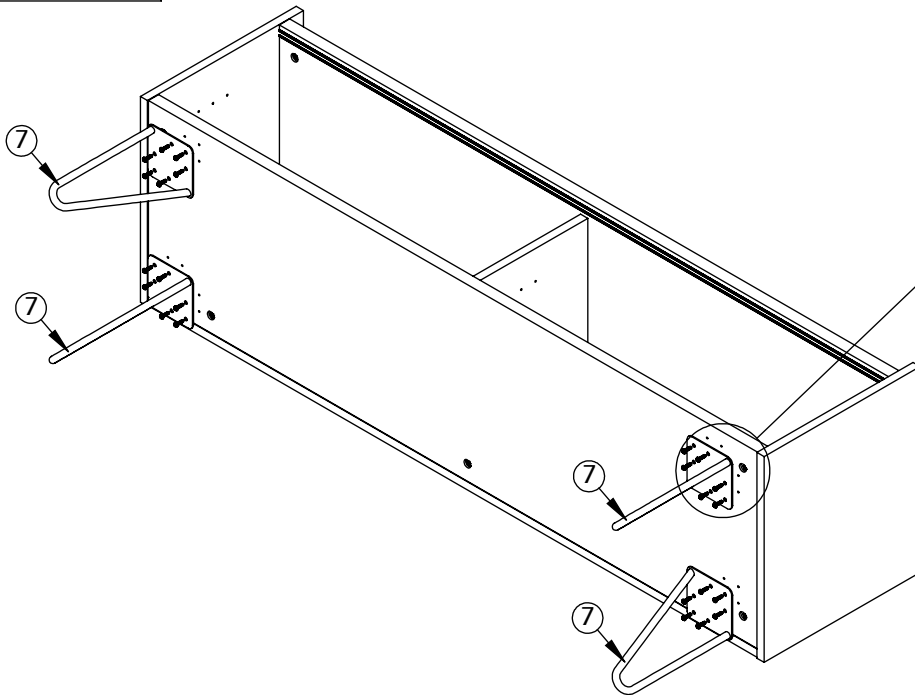
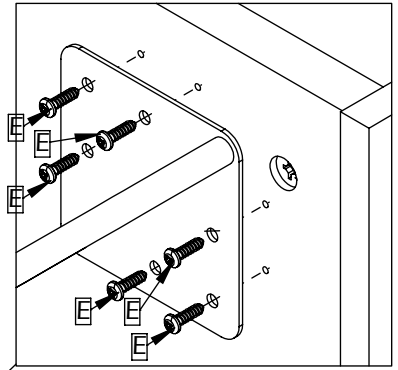
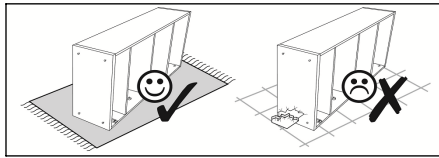

10

F-4x

K-10x/8x

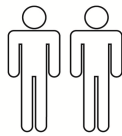

Ø6,5x16mm

Ø20x0,5mm

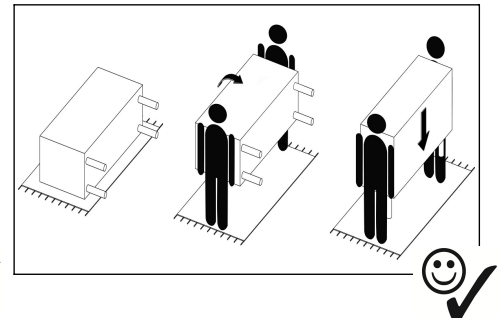
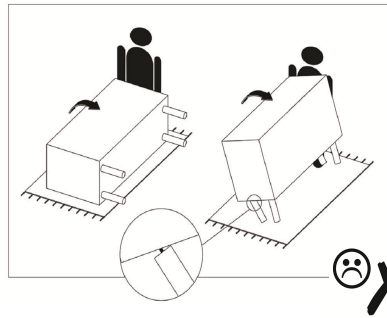

90°

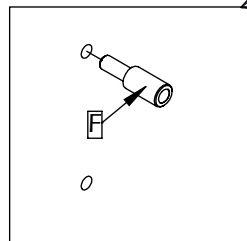
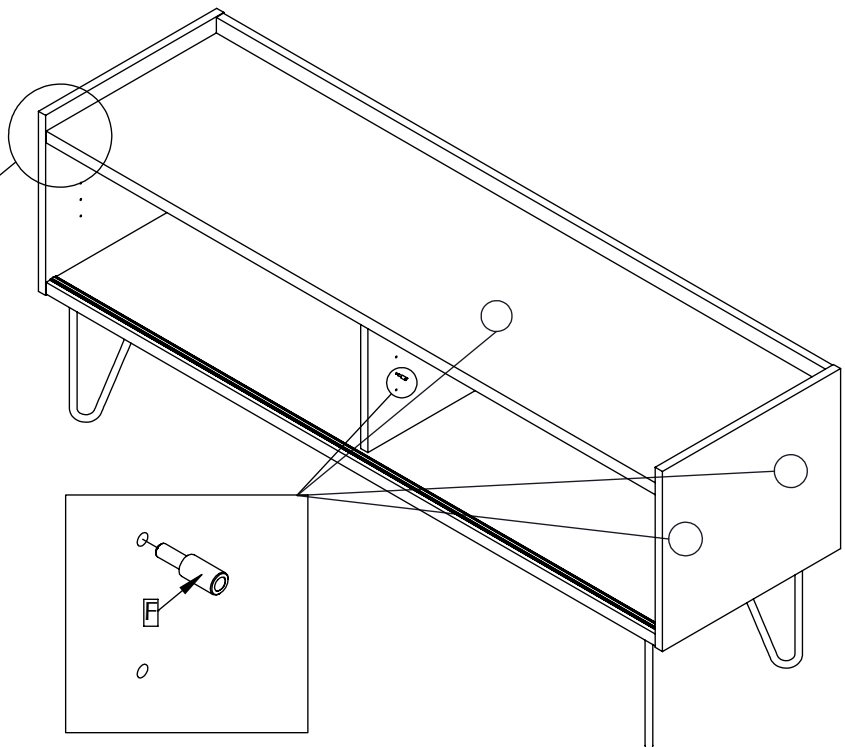
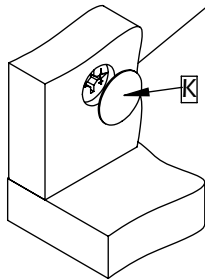
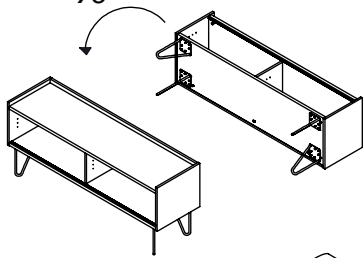

11

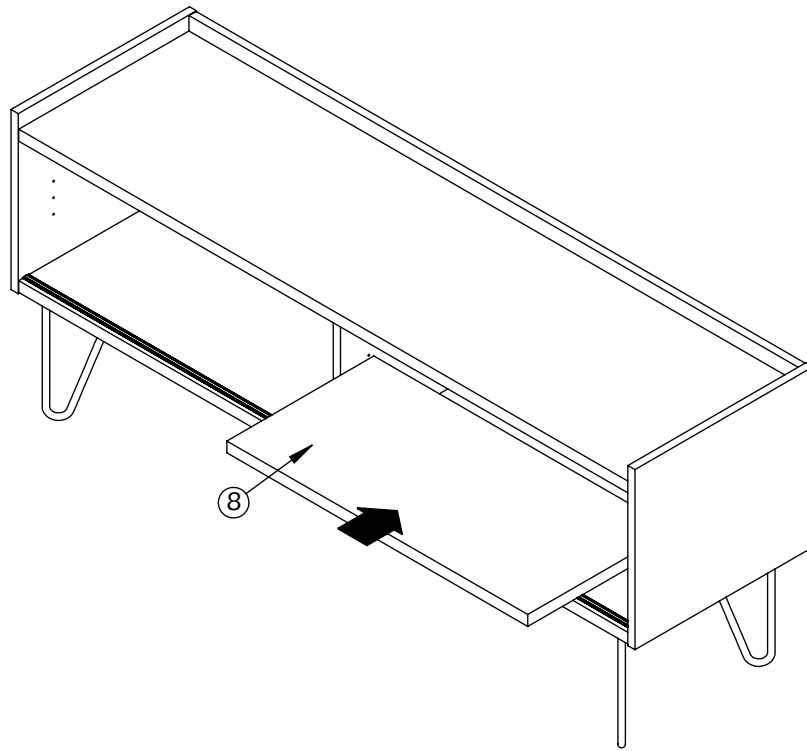

12

G-2x	H-2x	I-8x	J-4x
41x27x23mm	41x29x27mm	∅ 3x12mm	∅ 10x3mm

