

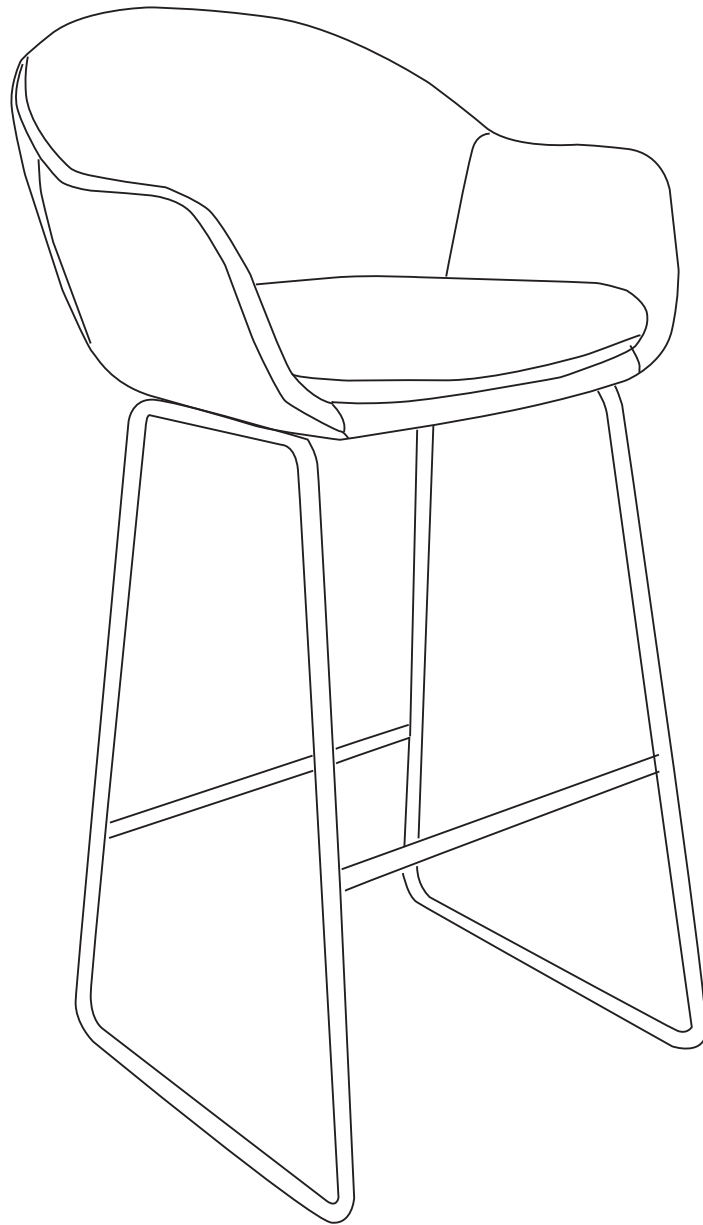













# Ally



<b>A*1</b> 	<b>B*1</b> 	<b>C*1</b> 	<b>D*1</b>  <b>400MM</b>	<b>E*1</b>  <b>420MM</b>
<b>F*2</b>  <b>M6*14</b>	<b>G*4</b>  <b>M6*25</b>	<b>H*4</b>  <b>M6*16</b>	<b>I*4</b>  <b>M6*25</b>	<b>J*1</b> 

**1**

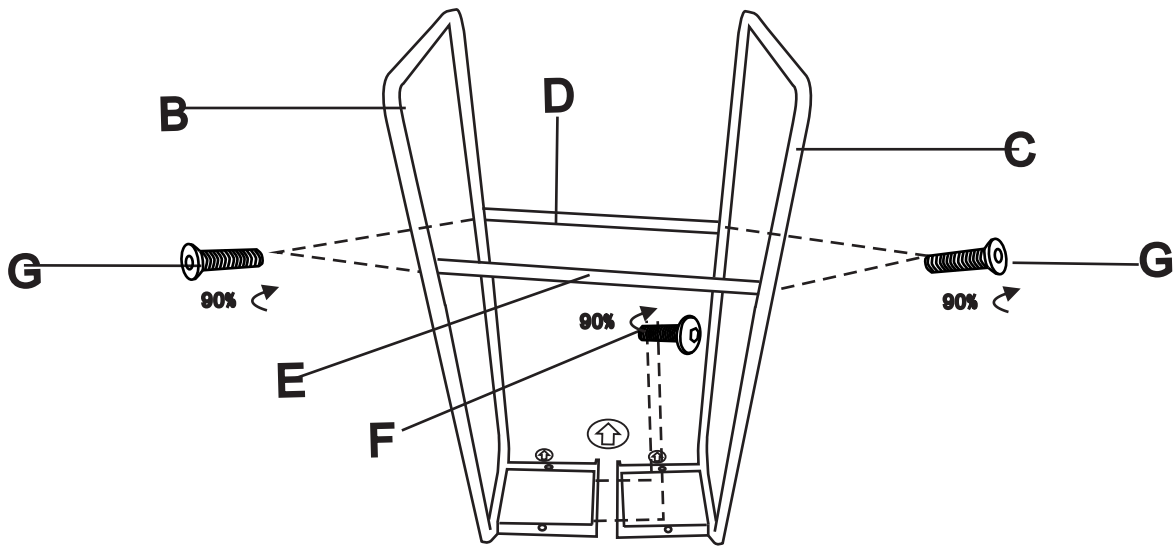

<b>F*2</b>  <b>M6*14</b>	<b>G*4</b>  <b>M6*25</b>	<b>J*1</b> 
---	---	---

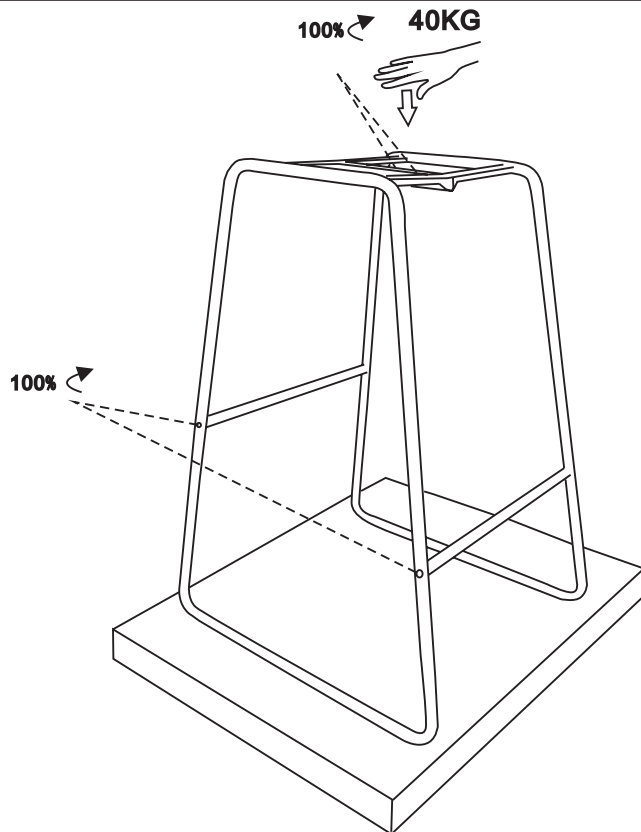

**2**



3

<b>H*4</b>  <b>M6*16</b>	<b>I*4</b>  <b>M6*25</b>	<b>J*1</b> 
---	---	---

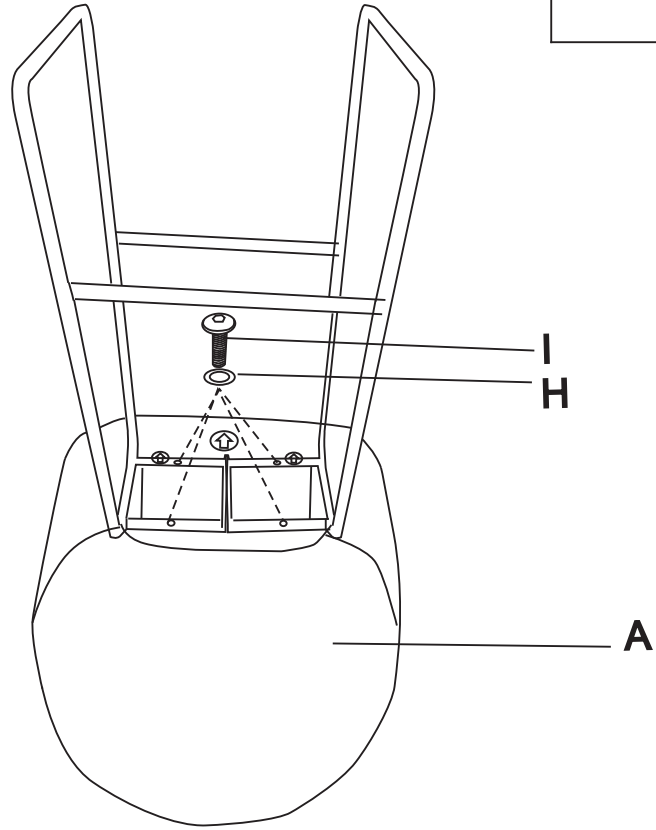

4

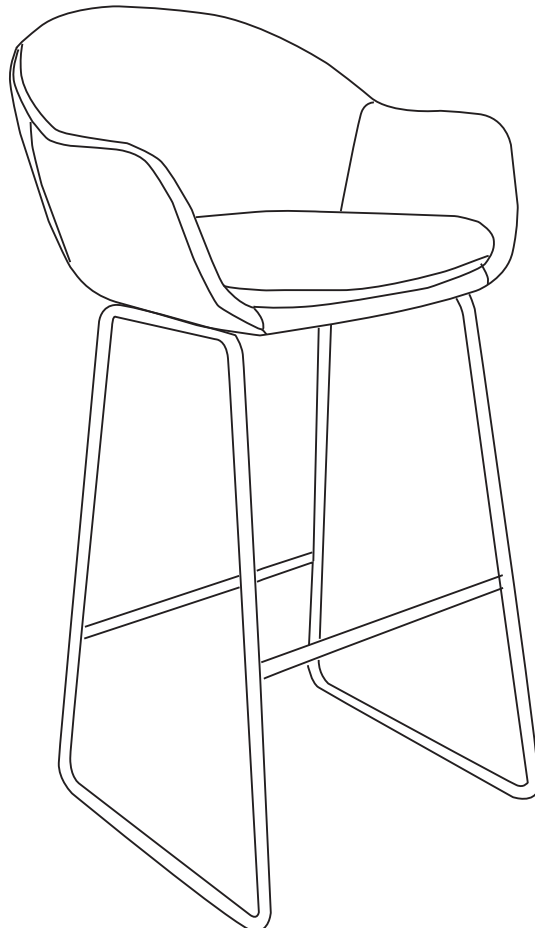

# ATTENTION

OBS – BITTE BEMERKEN – ATENCIÓN – AVIS IMPORTANT



**OBS**  
Vær venligst opmærksom på at det kan være nødvendigt at monterer eller udskifte beskyttelsesfødder som sikrer at underlaget ikke beskadiges. Kontakt venligst din møbelforhandler for yderligere oplysninger.

**ATENCIÓN**  
Tenga en cuenta que puede ser necesario instalar o sustituir tacos de protección para asegurar que la superficie no sea dañada. Póngase en contacto con su distribuidor de muebles para más detalles.

**EN**

## ATTENTION

Please note that it may be necessary to fit or replace protective caps to ensure that the flooring is not damaged. Please contact your furniture supplier for further information.

**DK**

**DE**

## BITTE BEMERKEN

Bitte beachten Sie, dass es notwendig sein könnte, die Schutzfüße zu montieren oder auszutauschen um sicherzugehen, dass der Untergrund nicht beschädigt wird. Für weitere Informationen kontaktieren Sie bitte Ihren Möbelhändler.

**ES**

**FR**

## AVIS IMPORTANT

Merci de noter qu'il peut être nécessaire d'installer ou remplacer des embouts pour éviter endommager le plancher. Pour des renseignements supplémentaires contactez votre magasin de meubles.