

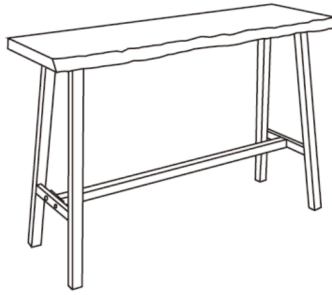





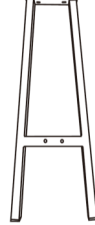

Assembly Instructions 2510/15

Bar Live Edge Table 125x46x92 cm

Main Material: Natural Acacia Wood / Black Powder Coating

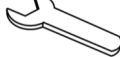

	① Top board	② Leg frame	③ Foot support	④ Screw (small)	⑤ Screw (large)	⑥ Washer	⑦ Nut	⑧ Spanner
Part Details	 1	 2	 1	 8	 4	 16	 4	 1

Assembly precaution:

- Please check whether parts are assembled before assembling.
- Please assemble with gloves or gloves and two people.
- Please go on soft carpet etc. in a place where scratches do not get on products, floor, surrounding furniture, etc.

Assembly procedure:

1. Place the ② leg frames on the back of the ① top board as show in in the illustration. Please refer to the enlarged view of *1, temporarily tighten the ④ screw (small) with ⑥ washer and ⑧ spanner.

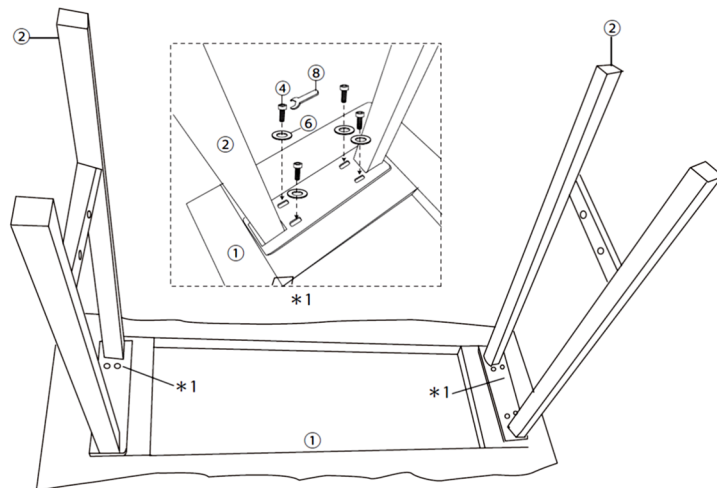

2. ③ Place the foot support as shown in the figure on the leg frame ②, temporarily tighten with ⑤ screw (large), ⑥ washer, ⑦ nuts and ⑧ spanner. Raise the main unit and tighten all the screws tightly.

